

CAUTION: Read instructions carefully and turn electricity off at main circuit breaker panel before beginning installation.

300121, 300122, 300123

WARNING - If any Special Control Devices are used with this Fixture, Follow the Instructions Carefully to assure full compliance with N.E.C. requirements. If there are any questions, contact a Qualified Electrical Contractor.

CAUTION - All glass is fragile, use care when handling Glass component(s) and or Lamp(s).

CANOPY MOUNTING & WIRE CONNECTION ASSEMBLY STEPS:

1. E → A
2. B,A → C
3. F → G 
4. D,H → A

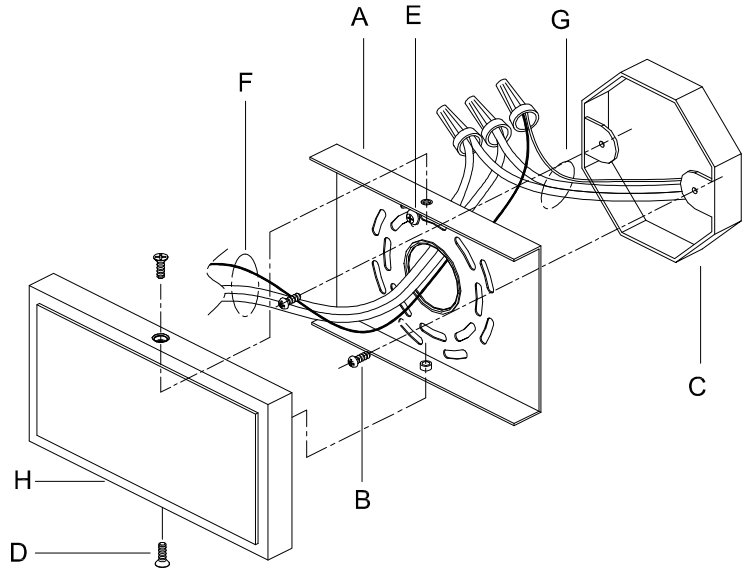
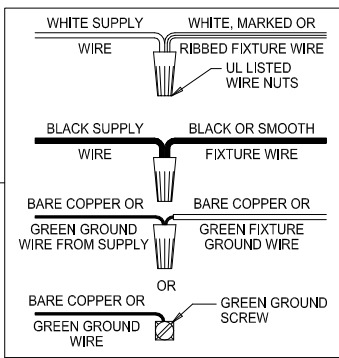

FIXTURE ASSEMBLY STEPS:

1. K,L,M → J
2. N → P
3. Q → P

B, C, G & P
(NOT FURNISHED)
(NO INCLUIDA)
(NON FOURNIE)

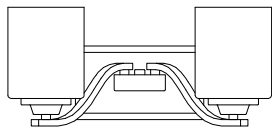

P300121

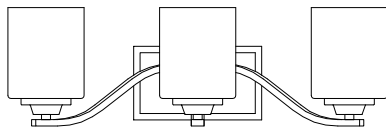

P300122

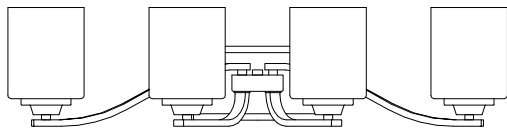

P300123

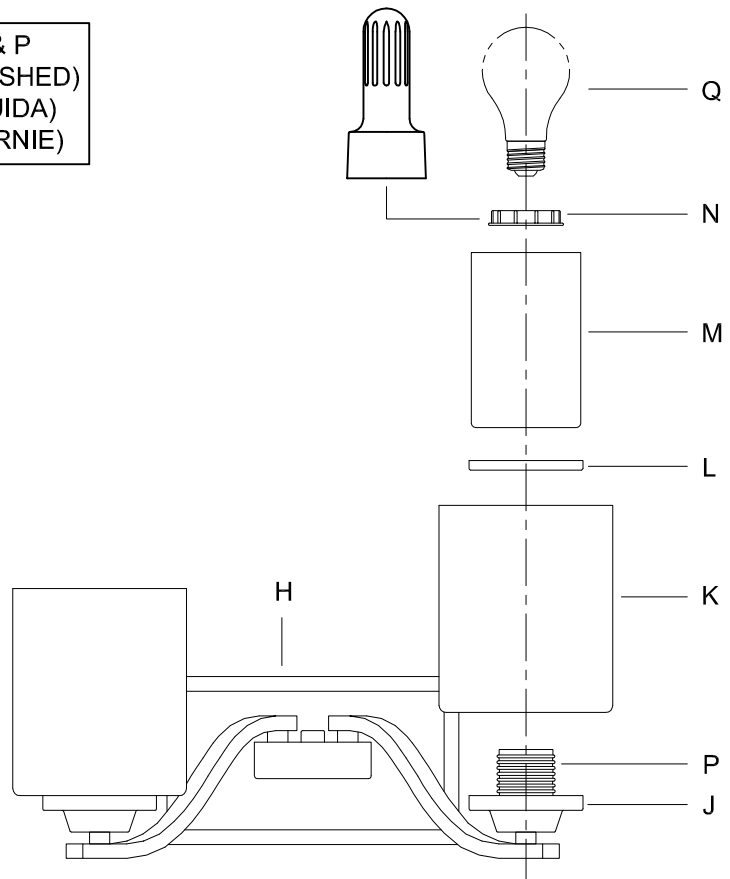

Instructions d'Assemblage et Installation

MISE EN GARDE: Lire les instructions avec soin et couper le courant au disjoncteur central avant de commencer l'installation.

AVERTISSEMENT - S'il y a d'autres mécanismes régulateurs qui s'emploient avec ce dispositif, suivre soigneusement les instructions pour satisfaire aux exigences NEC. Si vous avez des questions, consulter un électricien qualifié.
MISE EN GARDE - Le verre est toujours fragile; maniez le(s) composant(s) et/ou l' (les) ampoule(s) avec prudence.

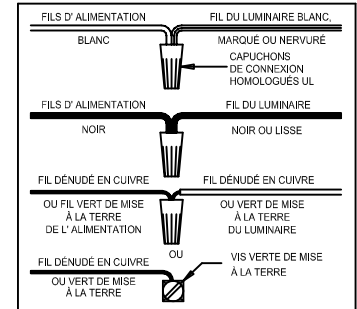

Instrucciones de ensamblaje e instalación

PRECAUCIÓN: Lea cuidadosamente las instrucciones y desconecte la electricidad del cortacircuitos principal antes de iniciar la instalación.

ADVERTENCIA - Si usa algún dispositivo especial de control con este aparato de luz, siga las instrucciones cuidadosamente para asegurar la completa conformidad con los requisitos N.E.C. Si existe alguna duda, contacte un electricista calificado.

PRECAUCION - El vidrio es frágil; tenga cuidado al manipular el (los) elemento(s) de vidrio y/o la(s) bombilla(s).

